

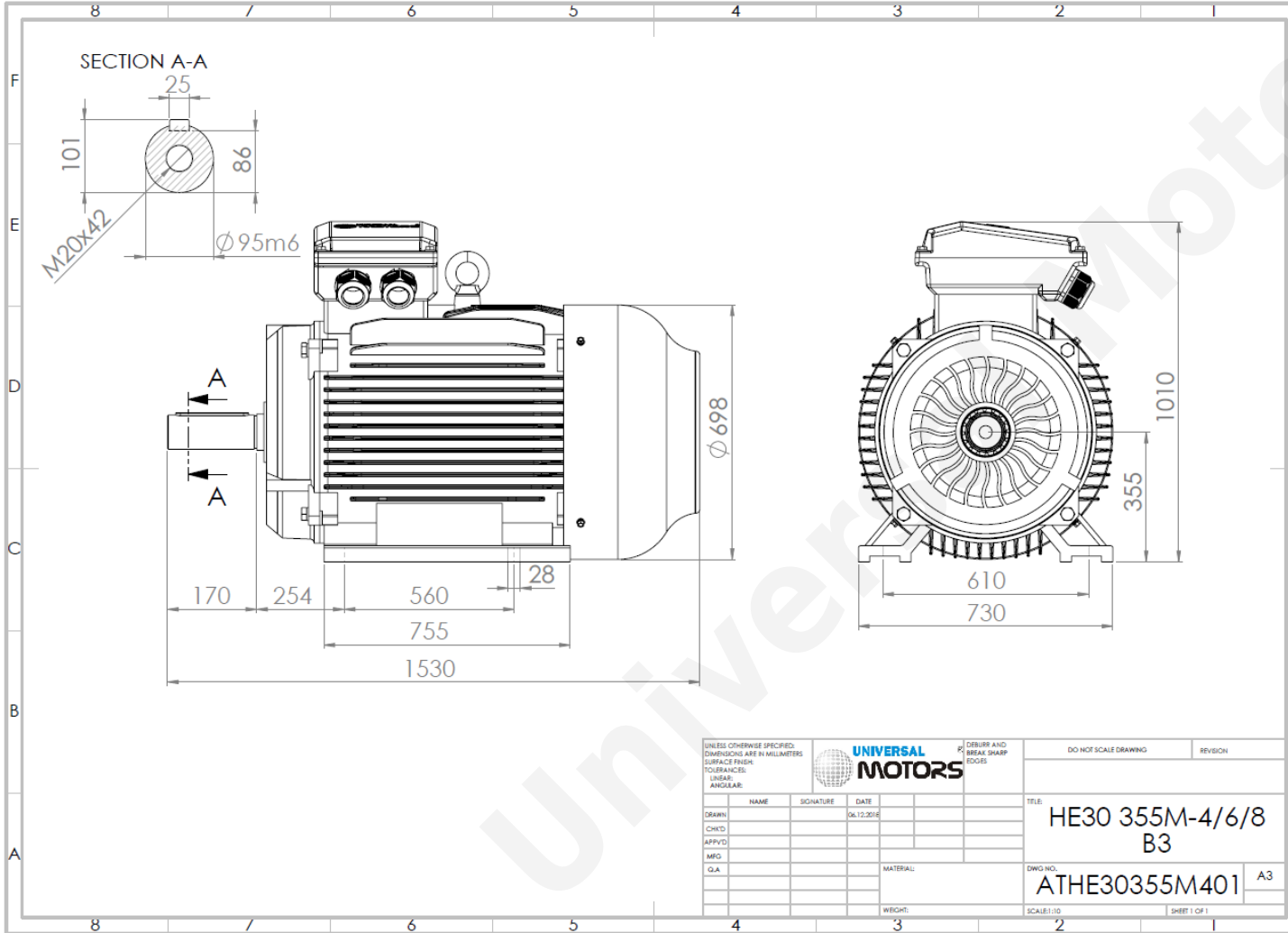

TECHNICAL DATA

Three Phase Electric Motors - Cast Iron Frame
 HE30 355 M-6 IE2
 200 kW / 270 Cv
 990 RPM



Motor type:	HE30 355 M-6 IE2
Output:	200 kW / 270 Cv
Speed (min ⁻¹):	990 RPM
Frequency:	50 Hz
Voltage:	400 V
Current:	349 A
Power factor (Cos ϕ):	0.87
Poles:	6
Insulation class:	F
Temperature rise Class:	B
Efficiency 50%:	94.3 %
Efficiency 75%:	95.3 %
Efficiency 100%:	95.0 %
Torque:	1929 N.m
Tstarting/Tnominal:	2.0
Istarting/Inominal:	6.7
Tmaximum/Tnominal:	2.0
Noise:	74 Db(A)
Weight:	1500 Kg
Bearing DE:	NU 322
Bearing NDE:	6322 C3

Regime - S1

Altitude - 1000m

Environment Temperature - 40°C

CONTACTS:

UNIVERSAL MOTORS Tel: +351 252 299 080
 Rua de São Brás, 745 Fax: +351 252 299 089
 4480-782 VILA DO CONDE Mail: geral@universalmotors.pt

* References applied only in the UK